

Data Sheet

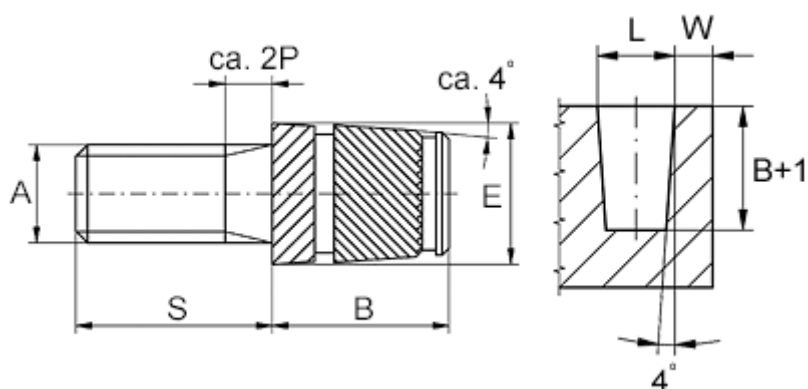

Article number: 12858100035860
Description: KLEE-coil 858 100 035.860
M3,5 Brass

Measures



Male thread A	= M3,5x0,6
Min distance to edge W	= 1.8
Mounting length B	= 6.0
Outer diameter E	= 5.4
Pin length S	= 16
Recommended bore diameter W +0.1	= 5.2